



AMERICAN CRAFTSMANSHIP SINCE 1933



2012 LAWN & GARDEN
EQUIPMENT CATALOG



AMERICAN CRAFTSMANSHIP SINCE 1933



Selecting the Right Mower	4
Ariens Ride On Mowers	
Zoom Zero-Turn Mowers	8-13
Lawn & Garden Tractors	14-15
Riding Mower Accessories	16-18
Ariens Walk Behind Mowers	
Wide Area Walk	20
Classic LM's	21
Value Walk Behinds	22
Ariens Chore Products	
Power Brushes	24
Log Splitters	25
Tillers	26
String Trimmer/Edger	27
Product Specifications	28-32
Financing	34



A WORD FROM dan ariens

When you choose an Ariens® product you become part of our rich 79-year heritage. When my great-grandfather Henry Ariens started building equipment in 1933, he built durable products designed to be reliable year after year – generation after generation.

We continue to produce products at our small-town manufacturing facilities in Wisconsin and Nebraska. Ariens equipment is designed, fabricated, assembled and tested by dedicated employees who take pride in American craftsmanship.

Our company vision is simple. We are Passionate People Astounding Our Customers. As a family-owned company, we understand service is just as important as the product itself. When you purchase an Ariens product, you can feel confident we stand behind our products. Ariens' network of independent power equipment dealers has been servicing our equipment from the beginning and can help keep your products running at peak performance.

Ariens continues to manufacture products with the same drive for quality and respect for our customers that began in the early days. We do this with a single goal in mind – so you can pass the power of our equipment on to your next generation!

Dan Ariens

President

selecting the right mower

Selecting the right mower is not an easy task. But if you pick the right mower for your yard it can save you time and money. Here are a few helpful hints to help you find your next mower.

Yard Size:

Selecting the right mower starts with the size of your yard. Matching the deck size with the yard size will help you mow more efficiently. See the chart below for recommended deck sizes.

YARD SIZE	Recommended Deck Size	Recommended Product
LESS THAN 0.5 ACRE	21"	Value LM, CLassic LM
.5 TO 1 ACRE	Up to 42"	WAW 34, Tractor, Zoom, Zoom XL
1 TO 2 ACRES	42" - 48"	Tractor, Zoom, Zoom XL, Max Zoom
2 ACRES OR MORE	46" - 60"	Zoom XL, Max Zoom

Number of Obstacles in Your Yard:

Maneuvering around obstacles is necessary when mowing. If there are many obstacles such as trees, flower beds, or landscaping in your yard, a zero-turn mower or a walk behind mower may be the best choices. Tractors can be limited in their ability to maneuver around objects and may require additional follow-up trimming.

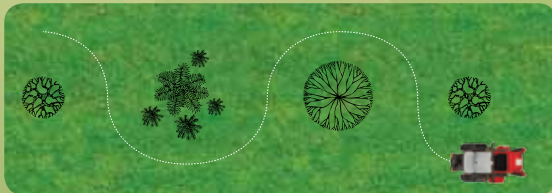

Attachments:

If you plan to use your machine for more than just mowing then you need to make sure that the mower can accommodate the attachments you need. Both riding tractors and zero-turn mowers can usually accommodate your needs. If you plan to use ground engaging attachments on a regular basis, such as an aerator or dethatcher, a machine with larger transmissions is recommended. A garden tractor or a larger zero-turn mower are your best options.



riding mowers



Max Zoom

8-9



Zoom XL

10-11



Zoom

12-13



Tractors

14-15



16-18

Accessories



zero-turn mower benefits

How much is your time worth?

You can cut your mowing time in half using a zero-turn mower instead of a traditional riding lawn tractor. Here are some of the time-saving features of zero-turn technology:

Drive at a Faster Speed

Zero-turn mowers are designed to cut grass nearly twice as fast as traditional lawn tractors so your straight line mowing speed is improved. A typical lawn tractor cuts at a speed of 3-4 mph while a typical zero-turn mower cuts at a speed of 5-8 mph.

Maneuver Around Obstacles

The maneuverability of zero-turn mowers allows you to easily mow around trees, flower beds and other obstacles in your yard more easily than with a steering wheel vehicle such as a riding lawn tractor.

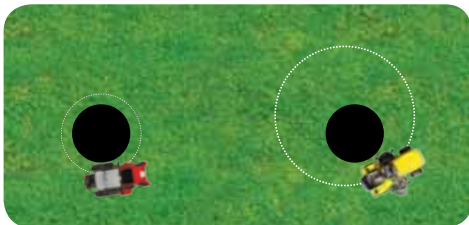

Eliminate Follow-Up Trimming

With an unobstructed view of the cutting deck, zero-turn mowers make it easy to cut very close to your trim edges. You can nearly eliminate the need to trim hard-to-reach areas with a push mower or a string trimmer after you've finished mowing.



Mow in a Single Pass

When you get to the end of your yard and have to turn around and come back, you literally can spin 180 degrees and come straight back without having to back up and cut the strips of grass you would miss when making the turn with a lawn tractor. When all things are equal, a zero-turn mower will allow you to cut your lawn more efficiently.

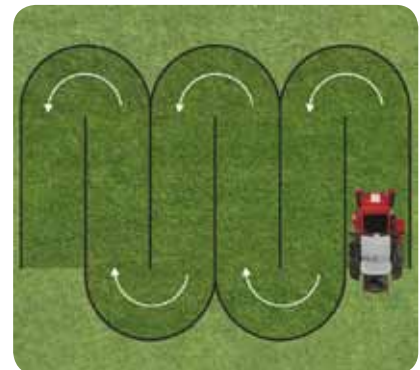

Zero-Turn mowing pattern

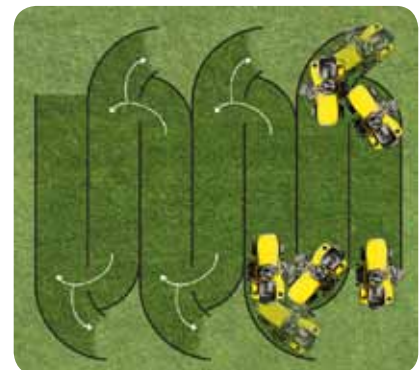

Tractor mowing pattern



Scan with mobile device for more zero-turn benefits.

www.whyzereturn.com

anatomy of a zero-turn

Dual Footrest Zone

Comfortably accommodates operators of various heights

Commercial Style 4 Point Deck Hanging System

Minimizes scalping over uneven terrain and offers unmatched longevity and includes tool-less removal

Anti-Scalping Wheels

Help to keep your deck level and prevent scalping of your lawn

Mowing Deck

Choose between stamped steel or fabricated designs ranging from 34"- 60" in size

Fuel Tanks

Large Capacity fuel tanks to allow you more time between refueling

Engine Hood

Isolate the operator from excess noise and heat from the engine, while pivoting fully forward to easily access serviceable components

Twin Lever Steering

Fully adjustable control arms accommodate operator and flip out to make it easier and safer to enter or exit the mower

Foot Operated Deck Lift

Makes it quick and easy to adjust the height of cut

Maintenance Free Front Caster Bushings

Require no grease and are designed for long life

Large Discharge Chute

Expels grass clippings faster and farther. Rubber chutes on some models for extra durability and eliminate mower contact damage to trees or other landscaping objects

Blade Engagement

Electric engagement for a smooth, effortless engagement of the mowing blades

Cup Holder

For holding your favorite beverage to keep you hydrated on a warm day

Seat

Plush cushioned seats to aid in operator comfort. High back seats and arm rests offer enhanced comfort and support

Powerful Engine Options

Single Cylinder or Twin Cylinder options. Ranging from 14.5 HP to 26 HP to tackle the toughest mowing conditions

Rear Bumper

Designed to accept multiple attachments and accessories (with additional hitch kit on some models)

Hydrostatic Drive System

Two independent wheel motors controlled by two steering levers provide infinite maneuverability which literally cuts your mowing time in half



max zoom®

handle your backyard like a pro



MODEL OVERVIEW:

Max Zoom®	Model #	Kohler® Courage Twin	Kohler® Courage Pro Twin	Cutting Width	Ground Speed (Fwd/Rev)	Fuel Capacity
Max Zoom® 60	991087	•	25 HP/ 725 CC	60"	8 MPH/4 MPH	6.0 GAL. / 22.7 L
Max Zoom® 52	991086	24 HP/ 725 CC	•	52"	8 MPH/4 MPH	6.0 GAL. / 22.7 L
Max Zoom® 48	991085	23 HP/ 725 CC	•	48"	8 MPH/4 MPH	6.0 GAL. / 22.7 L

max zoom[®] features:

4-Point Commercial Style Deck Hanging System provides the durability you would expect on a professional machine.

10-Gauge Fabricated Deck with $\frac{3}{8}$ " reinforced leading edge ensures lasting strength and durability.

Hydro-Gear[®] ZT-3100 Series Transaxles provide more torque/load capacity, which is similar to Professional Series mowers.

Fully Adjustable Control Arms with 3 mounting positions offer options to accommodate the operator; with vibration isolators adding operator comfort. Handles flip out to make it easier to enter or exit the mower.

Welded Steel Frame with a tubular structure provides the strength and rigidity of this mower. The backbone of this product is similar to what you find in a commercial grade mower.

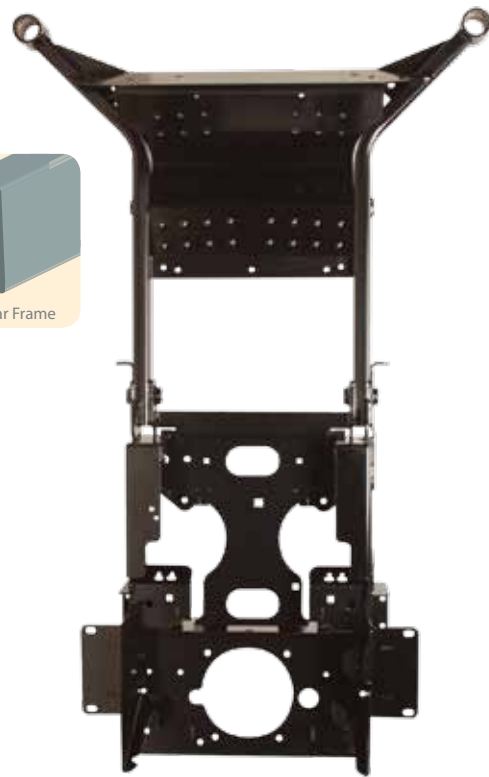
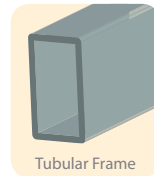

zoom[®] xl

a new definition for razor sharp performance



MODEL OVERVIEW:

Zoom [®] XL	Model #	Kohler [®] Courage twin	Cutting Width	Ground Speed (Fwd/Rev)	Fuel Capacity
Zoom [®] XL 54	915173	24 HP/ 725 CC	54"	6.5 MPH/3 MPH	3.8 GAL. / 14.4 L
Zoom [®] XL 48	915165	23 HP/ 725 CC	48"	6.5 MPH/3 MPH	3.8 GAL. / 14.4 L
Zoom [®] XL 42	916163	23 HP/ 725 CC	42"	6.5 MPH/3 MPH	3.8 GAL. / 14.4 L

zoom[®] xl features:

Fully Tubular Frame provides structural rigidity for added strength and stability versus a c-channel frame

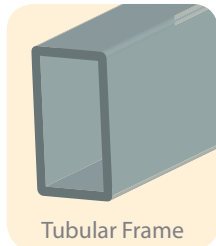

Tubular Frame



C-Channel Frame

10-Gauge Fabricated Deck provides excellent cut quality and durability that is expected from a commercial machine.

Hydro-Gear[®] ZT-2800 Series Transaxles deliver a smooth driving experience.

Foot-Operated Deck Lift makes it quick and easy to adjust the height of cut. Adjustments can be made in ½" increments ranging from 1.5"- 4.5".

Fully Adjustable Control Arms can be adjusted in three different directions to accommodate operators of different sizes. The handlebars also flip open to make it easier to enter or exit the mower.

Kohler Courage twin cylinder, OHV engines provide power, performance and convenience, ranging from 22hp to 24hp.



Limited
5 Year
Frame & Deck/Shell
Warranty



zoom[®]

engineered for performance, designed for your lifestyle



MODEL OVERVIEW:

Zoom [®]	Model #	Kohler [®] Courage Twin	Briggs & Stratton [®] Single	Cutting Width	Ground Speed (Fwd/Rev)	Fuel Capacity
Zoom [®] 50	915161	23 HP/725 CC	•	50"	6 MPH/3 MPH	2.0 GAL. / 7.5 L
Zoom [®] 42	915159	20 HP/725 CC	•	42"	6 MPH/3 MPH	2.0 GAL. / 7.5 L
Zoom [®] 34	915157	•	14.5 HP/500 CC	34"	6 MPH/3 MPH	2.0 GAL. / 7.5 L

zoom[®] features:

Compact Design offers enhanced maneuverability. The Zoom 34 features a 34" mowing deck that is designed to fit through a standard 36" gate.

4-Point Deck Lift System provides unmatched deck stability. Stand on it and you will feel the difference.

Deck Washout Port is a convenient way to keep your deck clean and maintain optimal performance. (Zoom 42" and Zoom 50" only)

Adjustable Sliding Seat and Control Levers for comfort while operating the machine. (Sliding Seat on Zoom 42" and Zoom 50" only)

Enhanced Operator Comfort is delivered with the 18" high back seat. (Zoom 42" and 50" models only)

Foot-Operated Deck Lift makes it quick and easy to adjust the height of cut. Adjustments can be made in ½" increments ranging from 1.5"- 4.5".

12-Gauge, Stamped XLerator™ Deck engineered for maximum air flow delivering an exceptional cut and lasting performance. (Zoom 42" and Zoom 50" models only)



Limited
5 Year
Frame & Deck/Shell
Warranty



tractors

power that puts you in the driver's seat



MODEL OVERVIEW:

Tractors	Model #	Kohler® Courage Single	Kohler® Courage Twin	Briggs & Stratton® V-Twin	Cutting Width	Turning Radius	Ground Speed (Fwd/Rev)	Fuel Capacity
Garden Tractor 54	936055	•	25 HP/725 CC	•	54"	18"	5.5 MPH/ 2.5 MPH	4 GAL. / 15.2 L
Lawn Tractor 54	936059	•	25 HP/725 CC	•	54"	16"	5.5 MPH/ 2.5 MPH	3 GAL. / 11.4 L
Lawn Tractor 48	936058	•	22 HP/725 CC	•	48"	16"	5.5 MPH/ 2.5 MPH	3 GAL. / 11.4 L
Lawn Tractor 46	936053	•	•	22 HP/656 CC	46"	16"	5.5 MPH/ 2.5 MPH	2.5 GAL. / 9.5 L
Lawn Tractor 42	936051	19 HP/597 CC	•	•	42"	16"	5.5 MPH/ 2.5 MPH	2.5 GAL. / 9.5 L

tractor features:

The Ariens tractor series is designed to be versatile and dependable to help you complete the many chores around the yard, offering powerful engine options and exceptional cutting performance.

Smooth Hydrostatic Transmissions provides optimized speed making mowing easy. The 42" and 46" models control speed with a fender mounted lever. The 48" and 54" models feature a pedal controlled speed adjustment feature for forward and reverse.

Operator Comfort is enhanced with 15" high back seats that can be adjusted forward and back to accommodate the operator. The steering wheel is also angled for optimal driver position.

Easy to reach levers & controls and a wide step through design allows for easy mounting and dismounting of the mower.



baggers

Large capacity bagger options make it easier and more efficient to clean up around the yard. Bagger options are great for spring and fall cleanup as well as regular collection of grass clippings. Durable construction for lasting performance and large capacities will have you mowing longer and stopping less.



◀ 3-BAG POWERED BAGGER:

- 9-bushel capacity
- Heavy-duty cloth bags
- Grass Pump assist
- Easy deck mount with spindle-driven fan
- Fits on all Zoom XL and Max Zoom models



NON-POWERED BAGGER: ▶

- 6-bushel capacity
- Higher air/grass velocity generated by the deck's geometric shape
- Power result without a grass pump assist
- Fits on all Zoom 34, Zoom 42 and Zoom 50 models

attachments & accessories

the right tools for the job

36" POLY ROLLER

- Can be used for multiple applications around the yard, providing the benefits of packing down newly sown seed or leveling uneven ground
- Lightweight when empty for easy transport and storage
- Poly construction for rustproof durability
- 18" diameter x 36" wide

48" TOW PLUG AERATOR

- Opens the soil to water, air & nutrients for healthier root growth
- 48" weight tray holds up to 175lbs for increased soil penetration
- Eight spools of aerator knives that are galvanized for rustproof durability
- 10" x 4" pneumatic tires allow for smooth transportations
- Easy to use cantilever transport handle for easy raising and lowering

attachments & accessories

the right tools for the job



◀ CONVERTIBLE DUMP CART

- Perfect solution to help with the many chores around the yard, like hauling debris or cleaning up the yard
- Converts in seconds between push and tow cart for versatility
- 500 lb capacity for larger loads
- 30.5" x 4" x 11" bed size
- Durable poly construction cleans up quickly and lasts for years
- Large pneumatic tires allow for easy maneuverability



CHROME WHEEL COVERS



OPERATOR CONTROLLED CHUTE BAFFLE



SUN SHADE



HITCH KIT



FLEX TEND™ SHOULDER SUPPORT SYSTEM



DETHATCHER



15-GALLON SPRAYER



SPREADER

Visit www.ariens.com to view a full listing of available attachments and accessories.

Some attachments and accessories are not available for every model. For additional details consult your Ariens dealer.

walk behind mowers



WAW

20

Classic LM

21

Value LM

22



wide area walk

take on the whole wide world



WIDE AREA WALK 34

- Two-spindle, 12-gauge stamped steel, 34" deck delivers a better overall quality of cut
- 7 Cutting positions ranging from 1.75"- 3.5"
- Variable speed belt drive system
- 3.5 mph forward / 2 mph reverse
- Two-hand start, passive parking brake and passive blade stop elevate safety and operator confidence
- 8" Front swivel wheels elevate maneuverability



MODEL OVERVIEW:

Walk-Behinds	Model #	Briggs & Stratton® Single	Cutting Width	Ground Speed (Fwd/Rev)	Fuel Capacity
WAW 34	911413	14.5 HP/500 CC	34"	3.5 MPH/2 MPH	2.5 GAL. / 9.5 L



classic walks

The affordable Ariens walk-behind mowers are designed to maximize operator comfort without compromising price and performance. Each mower features a compact design and easy maneuverability for optimal cutting.



**CLASSIC LM
SWIVEL WHEEL**

CLASSIC LM'S

- 14-Gauge stamped steel deck
- 21" Cutting width for optimal mowing
- 6 Cutting positions
- 1"- 3.25" Cutting heights
- 4 Position adjustable handlebar
- Available in straight axle or swivel front axle designs
- 3-in-1 cutting system (side discharge, mulch, bag)
- High lift blades to maximize bagging efficiency

MODEL OVERVIEW:

Walk-Behinds	Model #	Kawasaki® FJ180V	Kohler® XT-7	Cutting Width	Variable Ground Speed	Axle	Fuel Capacity
Classic LM21SW	911184	179 CC	•	21"	0-4 MPH	Swivel Wheel	0.53 GAL. / 2 L
Classic LM21S	911183	179 CC	•	21"	0-4 MPH	Straight	0.53 GAL. / 2 L
Classic LM21	911160	•	173 CC	21"	•	Straight	0.37 GAL. / 1.4 L

S - Straight Axle SW - Swivel Wheel



value walks

walk your way to cutting perfection



PUSH MOWER

VALUE WALK BEHINDS

- 12-Gauge stamped steel deck
- 21" Cutting width for optimal mowing
- 5 Cutting positions to manicure the lawn to your specification
- 1.25" - 3.42" Cutting heights
- 3-in-1 cutting system (side discharge, mulch, bag)
- Folding handlebar for convenient storage

SELF PROPELLED MOWER

MODEL OVERVIEW:

Value Walk-Behinds	Model #	Honda® GCV 160	Briggs & Stratton® 550E	Cutting Width	Drive System	Fuel Capacity
Value 21 Self-Propelled Walk-Behind	961366	160 CC	•	21"	Self-Propelled	0.34 GAL. / 1.4 L
Value 21 Push Walk-Behind	961365	•	149 CC	21"	Push	0.24 GAL. / 1 L



chore

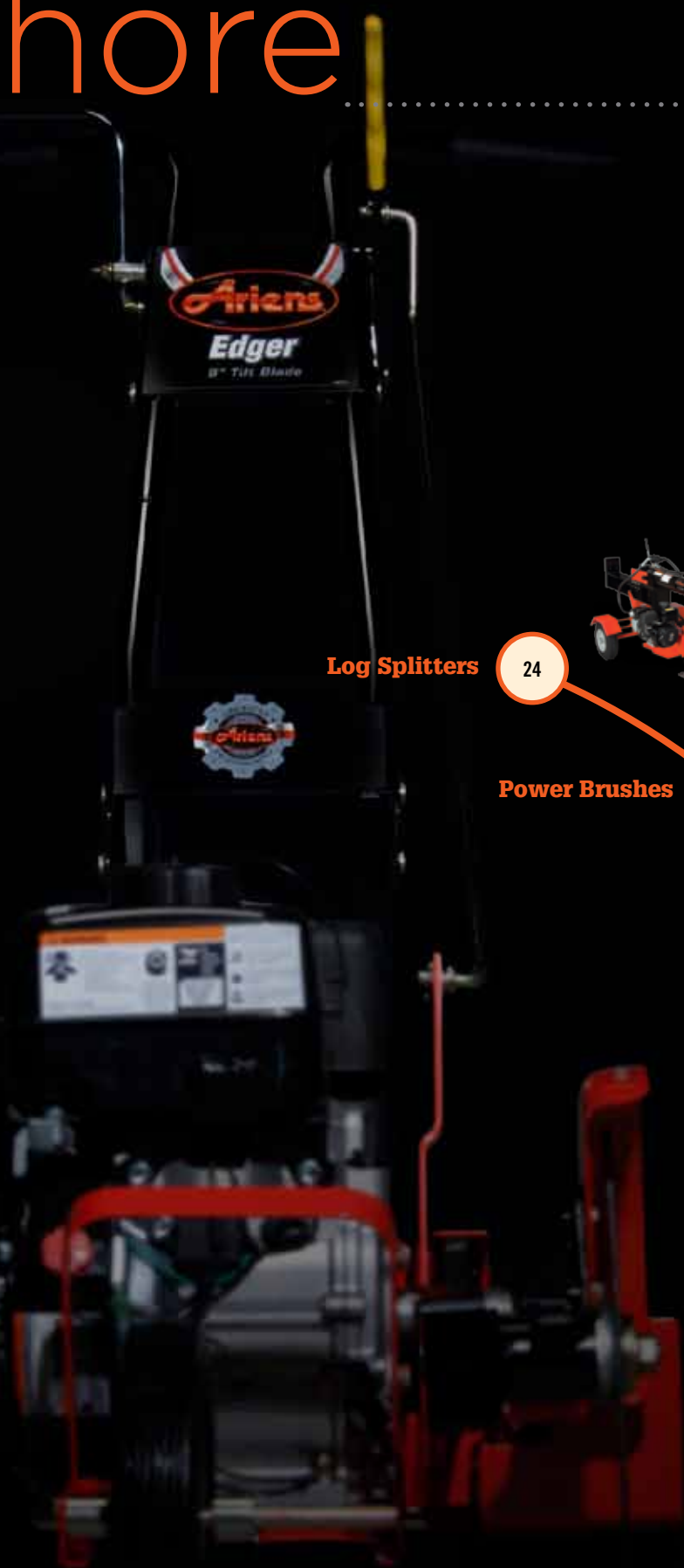

Log Splitters

24



Power Brushes

25



Tillers

26



Trimmer/Edger

27



chore

equipment that cuts your work time in half



Log Splitters Divide your work in half with a 27 or 34 ton Ariens Log Splitter. Centrally-located controls and an open operating zone allows for operation from either side of the machine. This significantly reduces the amount of bending, reaching, and walking required by the operator resulting in less operator fatigue and more time and energy for splitting.



MODEL OVERVIEW:

Chore & Finishing	Model #	Subaru®	Splitting Force	Log Capacity	Cycle Time	Fuel Capacity
34-Ton Log Splitter	917002	211 CC	34-TON	25"	18 SEC	0.95 GAL / 3.6 L
27-Ton Log Splitter	917001	169 CC	27-TON	25"	16 SEC	0.95 GAL / 3.6 L



give difficult work the brush off

Power Brushes The Ariens Power Brush Series features the same quality wheel drive system as the Ariens Sno-Thro®; delivering multi-tasking performance to efficiently remove snow, slush, or debris, clear decorative surfaces and even dethatch lawns.



POWER BRUSHES

- Robust 28" or 36" wide brush options
- All-season Subaru engine with electric start provides optimal performance in any weather
- Automatic traction control optimizes maneuverability; steering is effortless
- 40-degree brush head rotation with an operator controlled pivot lock makes changing the head direction easy
- Height adjustment system accommodates various surfaces and optimizes brush wear

LOG SPLITTERS

- Critical components like the engine and hydraulic hose are located at the front of the machine reducing the likelihood of damage from dropped logs
- Horizontal or vertical splitting capacity for splitting large, heavy logs; requires less operator lifting
- Aggressive wedge design for smooth log splitting capability
- Trailer front support includes a wheel, making it easier to move the splitter within the work area (34-ton model only)

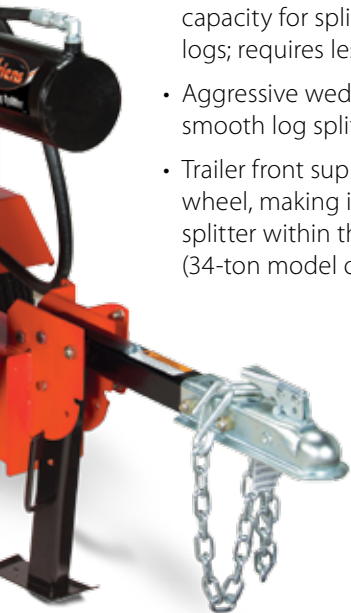

MODEL OVERVIEW:

Chore & Finishing	Model #	All Season Subaru®	Clearing Width	Ground Speed	Fuel Capacity
Power Brush 36	926045	265 CC	36"	6 FWD / 2 REV	1.6 GAL. / 6.1 L
Power Brush 28	921025	169 CC	28"	6 FWD / 2 REV	.95 GAL. / 3.6 L



chore

Precision Tillers Eliminate pesky weeds and get nutrient rich planting soil with Ariens Precision Tillers. Available in both front tine and rear tine models to suit your garden size and growing needs.



REAR TINE TILLER

- Chain drive transmission for added torque
- 17" tilling width
- 6.5" tilling depth
- Adjustable handle accommodates operator height
- Dual rotating tines for forward and reverse travel

FRONT TINE TILLER

- Chain drive transmission for added torque
- Three tilling widths - 12", 22" & 24"
- Heat treated tines for added durability
- 6" tilling depth
- Folding handlebar for easy storage
- Adjustable rubber wheels and depth stake

MODEL OVERVIEW:

Chore & Finishing	Model #	Subaru®	Tilling Width	Tilling Depth	Fuel Capacity
Front Tine Tiller	902032	6HP/ 169 CC	24"/22"/12"	6"	0.89 GAL. / 3.4 L
Rear Tine Tiller	901028	6HP/ 169 CC	17"	6.5"	0.89 GAL. / 3.4 L



String Trimmer The Ariens String Trimmer gets into those hard to reach areas, clearing the tallest and toughest grass and weeds. There is not an easier, faster, or more reliable way to put the finishing touch on a beautifully manicured landscape.

Edger Add curb appeal with the Ariens Edger. Its all-steel design and 110-degree pivoting head and drop wheel provide unbeatable value; allowing an operator to cut, trim or bevel nearly any landscape with one machine.



STRING TRIMMER

- 22" Cutting diameter
- 4-Position cutting height adjustment; easily tackles grass and weeds of various lengths
- Ergonomic, multi-position, fold down handle
- Deck swivels 15-degrees to the left or right for trimming along walls or fences
- Reinforced steel pivot head and 14-gauge stamped deck for added durability

EDGER

- 4-Position cutting height adjustment
- Curb hop feature for maneuverability and edging along curbs
- Easy lift transport handle
- Laterally adjustable front wheel
- 110° pivot head rotation for edging, trimming or beveling
- Operator presence control for safety

MODEL OVERVIEW:

Chore & Finishing	Model #	Kohler® XT-7	LCT	Cutting Width	Fuel Capacity
String Trimmer	946152	4.5 HP/173 CC	•	22"	0.37 GAL. / 1.4 L
Lawn Edger	986103	•	136 CC	N/A	0.71 GAL. / 2.7 L



specifications

PRODUCT NAME	Max Zoom® 60	Max Zoom® 52	Max Zoom® 48	Zoom XL® 54
MODEL NUMBER	991087	991086	991085	915173
ENGINE	Kohler Courage Pro Twin	Kohler Courage Twin	Kohler Courage Twin	Kohler Courage Twin
HORSEPOWER*	25 hp	23 hp	23 hp	24 hp
DISPLACEMENT (cc)	725 cc	725 cc	725 cc	725 cc
DRIVE SYSTEM	Hydro-Gear® ZT-3100 Transaxles	Hydro-Gear® ZT-3100 Transaxles	Hydro-Gear® ZT-3100 Transaxles	Hydro-Gear® ZT-2800 Transaxles
FUEL CAPACITY GALLONS (LITERS)	6 Gallons (22.7L)	6 Gallons (22.7L)	6 Gallons (22.7L)	3.8 Gallons (14.4L)
GROUND SPEED (APPROX. MPH) (FORWARD/REVERSE)	8 mph/4 mph	8 mph/4 mph	8 mph/4 mph	6.5 mph /3 mph
STARTER	Electric	Electric	Electric	Electric
DECK				
DECK MATERIAL	10 ga w/ .25" Spindle Reinforcement	10 ga w/ .25" Spindle Reinforcement	10 ga w/ .25" Spindle Reinforcement	10 ga w/ Doubler Plate
DECK CONSTRUCTION	Welded	Welded	Welded	Welded
NUMBER OF SPINDLES	3	3	3	3
BLADE TIP SPEED (FPM)	18,000	18,000	18,000	16,950
SPINDLE MATERIAL	Cast Iron	Cast Iron	Cast Iron	Aluminum
SPINDLE SHAFT	Steel	Steel	Steel	Steel
SPINDLE BEARINGS	Ball Bearing	Ball Bearing	Ball Bearing	Sealed
DECK DRIVE	Belt	Belt	Belt	Belt
DECK ENGAGEMENT	Electric Ogura® GT1A	Electric Ogura® GT1A	Electric Ogura® GT1A	Electric Warner®
DECK LIFT SYSTEM	Foot Operated	Foot Operated	Foot Operated	Foot Operated
CUTTING WIDTH	60"	52"	48"	54"
CUTTING HEIGHTS	1"- 5"	1"- 5"	1"- 5"	1.5"- 4.5"
CUTTING POSITIONS	9	9	9	7
WHEELS				
FRONT AXLE	Fixed	Fixed	Fixed	Fixed
FRONT	Smooth 13" x 5"- 6"	Smooth 13" x 5"- 6"	Smooth 13" x 5"- 6"	Smooth 11" x 4"
REAR	Turf 20" x 10"- 10"	Turf 20" x 10"- 10"	Turf 20" x 10"- 10"	Turf 20" x 10"
FEATURES				
HOOD	N/A	N/A	N/A	Standard
HEADLIGHTS	Optional	Optional	Optional	Optional
SEAT	High Back w/ Seat Springs & Arm Rests	High Back w/ Seat Springs & Arm Rests	High Back w/ Seat Springs & Arm Rests	High Back w/ Seat Springs, Lever Adjust & Arm Rests
HOOR METER	Standard	Standard	Standard	Standard
DIMENSIONS				
WEIGHT (LBS)	853	832	823	645
LENGTH	74.5"	74.5"	71.5"	69"
WIDTH	62.8" (w/o chute)	55.5" (w/o chute)	50" (w/o chute)	64" (w/ chute)
HEIGHT	42"	42"	42"	42"
WARRANTY				
MACHINE	3 Year Limited Consumer, 1 Year Limited Commercial			
DECK SHELL & FRAME	5 Year Limited			
SPINDLES	3 Year Limited			
ATTACHMENTS & ACCESSORIES				
OPTIONAL	3-Bucket Powered Bagger Kit, Mulching Kit, Trailer Hitch Kit, 36" Poly Roller, 48" Aerator, 48" Dethatcher, 15-Gallon Sprayer, Spreader, Dump Cart, Wheel Covers, Headlight Kit, Suspension Seat Kit, Lawn Stripping Kit, Discharge Cover Kit, Engine Guard, FlexTend™ Shoulder Support System, Operator Controlled Chute Baffle, Seat Cover, Mower Cover			3-Bucket Powered Bagger Kit, Mulching Kit, Trailer Hitch Kit, Wheel Covers, Sun Shade, Mower Cover

Zoom XL® 48	Zoom XL® 42	Zoom® 50	Zoom® 42	Zoom® 34
915165	915163	915161	915159	915157
Kohler Courage Twin	Kohler Courage Twin	Kohler® Courage Twin	Kohler® Courage Twin	Briggs & Stratton® Single Cylinder
23 hp	22 hp	23 hp	20 hp	14.5 hp
725 cc	725 cc	725 cc	725 cc	500 cc
Hydro-Gear® ZT-2800 Transaxles	Hydro-Gear® ZT-2800 Transaxles	Hydro-Gear® EZT Transaxles with 1" Axle Shafts	Hydro-Gear® EZT Transaxles with 1" Axle Shafts	Hydro-Gear® EZT Transaxles with 1" Axle Shafts
3.8 Gallons (14.4L)	3.8 Gallons (14.4L)	2.0 Gallons (7.5L)	2.0 Gallons (7.5L)	2.0 Gallons (7.5L)
6.5 mph /3 mph	6.5 mph /3 mph	6 mph/3 mph	6 mph/3 mph	6 mph/3 mph
Electric	Electric	Electric	Electric	Electric
10 ga w/ Doubler Plate	10 ga w/ Doubler Plate	12 ga	12 ga	12 ga
Welded	Welded	Stamped	Stamped	Stamped
3	3	3	3	2
16,800	17,000	17,800	17,000	17,500
Aluminum	Aluminum	Steel	Steel	Steel
Steel	Steel	Steel	Steel	Steel
Sealed	Sealed	Sealed	Sealed	Sealed
Belt	Belt	Belt	Belt	Belt
Electric Warner®	Electric Warner®	Electric Warner®	Electric Warner®	Electric Warner®
Foot Operated	Foot Operated	Foot Operated	Foot Operated	Foot Operated
48"	42"	50"	42"	34"
1.5"- 4.5"	1.5"- 4.5"	1.5"- 4.5"	1.5"- 4.5"	1.5"- 4.5"
7	7	7	7	7
Fixed	Fixed	Fixed	Fixed	Fixed
Smooth 11" x 4"	Smooth 11" x 4"	Smooth 11" x 4"	Smooth 11" x 4"	Smooth 11" x 4"
Turf 20" x 10"	Turf 20" x 8"	Turf 18" x 9.5"	Turf 18" x 8.5"	Turf 18" x 6.5"
Standard	Standard	Standard	Standard	Standard
Optional	Optional	N/A	N/A	N/A
High Back w/ Seat Springs, Lever Adjust & Arm Rests	High Back w/ Seat Springs, Lever Adjust & Arm Rests	High Back w/ Seat Springs, Lever Adjust	High Back w/ Seat Springs, Lever Adjust	Mid Back w/ Seat Springs
Standard	Standard	N/A	N/A	N/A
630	615	475	440	425
69"	69"	64"	64"	64"
58" (w/ chute)	52" (w/ chute)	62" (w/ chute)	54" (w/ chute)	42" (w/ chute)
42"	42"	43"	43"	37"
3 Year Limited Consumer	3 Year Limited Consumer			
5 Year Limited	5 Year Limited			
N/A	N/A			
Trailer Hitch Kit, 36" Poly Roller, 48" Aerator, 48" Dethatcher, 15-Gallon Sprayer, Spreader, Dump Headlight Kit, 54" Snow Blade, Two-Stage Snowblower, FlexTend™ Shoulder Support System, Seat Cover, Mower Cover, Engine Guard	2-Bucket Non-Powered Bagger Kit, Mulching Kit, Trailer Hitch Kit (Standard on 42" & 50" models), 36" Poly Roller, 48" Aerator, 48" Dethatcher, 15-Gallon Sprayer, Spreader, Dump Cart, Wheel Covers, FlexTend™ Shoulder Support System, Seat Cover, Mower Cover, Arm Rest Kit			

specifications *(con't.)*

PRODUCT NAME	Lawn Tractor 42	Lawn Tractor 46	Lawn Tractor 48	Lawn Tractor 54	Garden Tractor 54
MODEL NUMBER	936051	936053	936058	936059	936055
ENGINE	Kohler® Courage Single	Briggs & Stratton® V-Twin	Kohler Courage V-Twin	Kohler Courage V-Twin	Kohler® Courage V-Twin
HORSEPOWER*	19 hp	22 hp	22 hp	25 hp	25 hp
DISPLACEMENT (cc)	597 cc	656 cc	725 cc	725 cc	725 cc
DRIVE SYSTEM	Hydrostatic Fender Shift Lever	Hydrostatic Fender Shift Lever	Hydrostatic Foot Pedal	Hydrostatic Foot Pedal	Hydrostatic Foot Pedal
FUEL CAPACITY GALLONS (LITERS)	2.5 Gallons (9.5L)	2.5 Gallons (9.5L)	3.0 Gallons (11.4L)	3.0 Gallons (11.4L)	4.0 Gallons (15.2L)
GROUND SPEED (APPROX. MPH) (FORWARD/REVERSE)	5.5 mph/2.5 mph	5.5 mph/2.5 mph	5.5 mph/2.5 mph	5.5 mph/2.5 mph	5.5 mph/2.5 mph
STARTER	Electric (Bendix)	Electric (Bendix)	Electric (Bendix)	Electric (Bendix)	Electric (Bendix)
DECK					
DECK MATERIAL	12 ga	12 ga	11 ga	11 ga	10 ga
DECK CONSTRUCTION	Stamped	Stamped	Stamped	Stamped	Stamped
NUMBER OF SPINDLES	2	2	3	3	3
BLADE TIP SPEED (FPM)	19,000 (max)	19,000 (max)	19,000 (max)	19,000 (max)	19,000 (max)
SPINDLE MATERIAL	Cast Aluminum	Cast Aluminum	Cast Aluminum	Cast Aluminum	Cast Aluminum
SPINDLE SHAFT	Steel	Steel	Steel	Steel	Steel
SPINDLE BEARINGS	Sealed	Sealed	Ball Bearing	Ball Bearing	Greaseable
DECK DRIVE	Belt	Belt	Belt	Belt	Belt
DECK ENGAGEMENT	PTO Electric	PTO Electric	PTO Electric	PTO Electric	PTO Electric
DECK LIFT SYSTEM	Manual, Spring Assist	Manual, Spring Assist	Manual, Spring Assist	Manual, Spring Assist	Manual, Spring Assist
CUTTING WIDTH	42"	46"	48"	54"	54"
CUTTING HEIGHTS	1.5" - 4"	1.5" - 4"	1" - 4"	1" - 4"	1.5" - 4"
CUTTING POSITIONS	6	6	6	6	7
TURNING RADIUS	16"	16"	16"	16"	18"
WHEELS					
FRONT AXLE	Steel	Steel	Cast Iron	Cast Iron	Cast Iron
FRONT	15" x 6" - 6" Turf Saver	15" x 6" - 6" Turf Saver	15" x 6" - 6" Turf Saver	15" x 6" - 6" Turf Saver	16" x 6.5" - 6" Turf Saver
REAR	20" x 8" - 8" Turf Saver	20" x 8" - 8" Turf Saver	20" x 8" - 8" Turf Saver	20" x 8" - 8" Turf Saver	23" x 10.5" - 12" Turf Saver
FEATURES					
HOOD	Stealth	Stealth	Stealth	Stealth	Stealth
HEADLIGHTS	Yes	Yes	Yes	Yes	Yes
SEAT	High Back 15", Slide	High Back 15", Slide	High Back 15", Slide	High Back 15", Slide	High Back 15", Slide
HOOR METER	Yes	Yes	Yes	Yes	Yes
DIMENSIONS					
WEIGHT (LBS)	472	493	559	594	698
LENGTH	72.75"	72.75"	72.75"	72.75"	73.75"
WIDTH	45"	49.5"	52.5"	58.5"	58.5"
HEIGHT	46"	46"	46"	47"	47"
WARRANTY					
MACHINE	2 Year Limited Consumer				
ATTACHMENTS & ACCESSORIES					
OPTIONAL	Bagger Kit, Mulching Kit				

PRODUCT NAME	Wide Area Walk 34	Classic LM 21	Classic LM21 S	Classic LM21 SW	Value Walk Behind	Value Walk Behind
MODEL NUMBER	911413	911160	911183	911184	961365	961466
ENGINE	Briggs & Stratton®	Kohler® XT-7	Kawasaki® FJ180V	Kawasaki® FJ180V	Briggs & Stratton® 550E	Honda® GCV 160
HORSEPOWER*	14.5 hp	N/A	N/A	N/A	N/A	N/A
DISPLACEMENT (cc)	500 cc	173 cc	179 cc	179 cc	140 cc	160 cc
DRIVE SYSTEM	Variable Speed Belt Drive	Push	Infi-Speed® Variable Speed Drive	Infi-Speed® Variable Speed Drive	Push	FWD Self Propelled
FUEL CAPACITY GALLONS (LITERS)	2.5 Gallons (9.5L)	0.37 Gallon (1.4L)	0.53 Gallon (2L)	0.53 Gallon (2L)	0.24 Gallon (1L)	0.37 Gallon (1.4L)
GROUND SPEED (APPROX. MPH) (FORWARD/REVERSE)	3.5 mph Forward/ 2 mph Reverse	N/A	4 mph	4 mph	N/A	N/A
STARTER	Electric Start	Recoil	Recoil	Recoil	Manual Pull	Manual Pull
DECK						
DECK MATERIAL	12 ga	14 ga	14 ga	14 ga	12 ga	12 ga
DECK CONSTRUCTION	Stamped	Stamped	Stamped	Stamped	Stamped	Stamped
NUMBER OF SPINDLES	2	1	1	1	1	1
BLADE TIP SPEED (FPM)	18,000	18,000	18,000	18,000	19,000	19,000
SPINDLE MATERIAL	Steel	N/A	N/A	N/A	N/A	N/A
SPINDLE SHAFT	5/8"	N/A	N/A	N/A	N/A	N/A
SPINDLE BEARINGS	Sealed Ball	N/A	N/A	N/A	N/A	N/A
DECK DRIVE	Belt	Direct	Direct	Direct	NA	NA
DECK ENGAGEMENT	PTO Lever	NA	NA	NA	NA	NA
DECK LIFT SYSTEM	Manual	Manual	Manual	Manual	Manual	Manual
CUTTING WIDTH	34"	21"	21"	21"	21"	22"
CUTTING HEIGHTS	1.75" - 3.63"	1" - 3.25"	1" - 3.25"	1" - 3.25"	1.25" - 3.42"	1.25" - 3.42"
CUTTING POSITIONS	7	6	6	6	5	5
WHEELS						
FRONT AXLE	Swivel	Fixed	Fixed	Swivel	Fixed	Fixed
FRONT	Turf 8" x 1.75"	7.5"	7.5"	7.5"	8"	8"
REAR	Turf 13" x 6"	10.5"	10.5"	10.5"	8"	8"
DIMENSIONS						
WEIGHT (LBS)	280	100	104	121	85	85
LENGTH	67"	61.5"	61.5"	61.5"	36.25"	36.25"
WIDTH	42"	23"	23"	23"	21"	21"
HEIGHT	38"	38"	38"	38"	25.25"	25.25"
WARRANTY						
MACHINE	3 Year Limited Consumer	3 Year Limited Consumer	3 Year Limited Consumer	3 Year Limited Consumer	2 Year Limited Consumer	2 Year Limited Consumer
ATTACHMENTS & ACCESSORIES						
BAGGER KIT	Available	Standard	Standard	Standard	Standard	Standard
MULCHING KIT	Available	Standard	Standard	Standard	Integrated	Integrated
LEAF SHREDDER	N/A	Available	Available	Available	N/A	N/A
DETHATCHER	N/A	Available	Available	Available	N/A	N/A

PRODUCT NAME	Edger	String Trimmer
MODEL NUMBER	986103	946152
ENGINE	LCT	Kohler® XT-7
HORSEPOWER*	4.5 hp	4.5 hp
DISPLACEMENT (cc)	136 cc	173 cc
STARTING SYSTEM	Recoil	Recoil
DRIVE SYSTEM	Push	Push
FUEL CAPACITY	0.71 Gallon (2.6L)	0.37 Gallon(1.4L)
DECK		
DECK MATERIAL	12 ga	14 ga
DECK CONSTRUCTION	Formed	Stamped
NUMBER OF SPINDLES	1	1
BLADE DIAMETER	9 Inch	N/A
SPINDLE MATERIAL	Steel	N/A
SPINDLE SHAFT	1/2" Dia. Steel	N/A
SPINDLE BEARINGS	Sealed	N/A
DECK DRIVE	Belt	Belt
CUT ANGLE	110 Degrees	N/A
CUT POSITIONS	4	4
CUTTING WIDTH	N/A	22" w/ 15° Swivel to the Left and Right
CUTTING HEIGHTS	N/A	1.25" - 4.25"
OPERATOR SAFETY LEVER	Yes	N/A
WHEELS		
WHEEL DIAMETER	8"	N/A
WHEEL BEARINGS	Yes	N/A
DROP WHEEL FOR CURB	Yes	N/A
FRONT AXLE	Laterally Adjustable	N/A
FRONT	1.75" x 7.5"	N/A
REAR	1.75" x 7.5"	14"
DIMENSIONS		
WEIGHT (LBS)	72	83
LENGTH	44.75"	58"
WIDTH	19.75"	22"
HEIGHT	38"	41"
WARRANTY		
MACHINE	3 Year Limited Consumer	3 Year Limited Consumer

specifications (con't.)

PRODUCT NAME	Front Tine Tiller	Rear Tine Tiller
MODEL NUMBER	902032	901028
ENGINE	Subaru®	Subaru®
HORSEPOWER*	6 hp	6 hp
ENGINE DISPLACEMENT (cc)	169 cc	169 cc
DRIVE SYSTEM	Roller Chain	Chain / Gear
FUEL CAPACITY GALLONS (LITERS)	0.89 Gallon (3.4L)	0.89 Gallon (3.4L)
TINE SPEED	118 rpm	190 rpm
STARTER	Recoil	Recoil
DECK		
TILLING WIDTH	24"/22"/12"	17"
TINE DIAMETER	12"	13"
TILLING DEPTH	6"	6.5"
HANDLE	Foldable	Adjustable
WHEELS		
TIRE SIZE	1.75" x 8" Semi -Pneumatic	13" x 5"- 6" Pneumatic
DIMENSIONS		
WEIGHT (LBS)	115	230
LENGTH (INCHES)	27.5"	48"
WIDTH (INCHES)	25"	24.5"
HEIGHT (INCHES)	33.5"	34.5"
WARRANTY		
MACHINE	2 Year Limited Consumer	2 Year Limited Consumer
FEATURES		
SAFETY CLUTCH/HANDLE	Standard	Standard
FORWARD TILL	Standard	Standard
REVERSE TILL	N/A	Standard
DUAL ROTATING TINES	N/A	Standard
DEPTH STAKE	Standard	Standard
BUMPER	N/A	Standard

PRODUCT NAME	Power Brush 28	Power Brush 36
MODEL NUMBER	921025	926045
ENGINE	Subaru®	Subaru®
HORSEPOWER*	6 hp	9 hp
DISPLACEMENT (cc)	169 cc	265 cc
STARTING SYSTEM	120V/Recoil	120V/Recoil
FUEL TANK CAPACITY	.95 Gallon (3.6L)	1.6 Gallon (6.1L)
BRUSH WIDTH	28"	36"
BRUSH ROTATION ANGLE	40°	40°
BRUSH ROTATION CONTROL	Remote Trigger	Remote Trigger
INTERLOCK CONTROL	Standard	Standard
TIRE SIZE	15" x 5"	16" x 6.5"
TIRE TYPE	Directional Snow Tread	Directional Snow Tread
AXLE SYSTEM	Automatic Traction Control	Automatic Traction Control
SPEEDS: FORWARD/REVERSE	6 Forward/ 2 Reverse	6 Forward/ 2 Reverse
BRUSH DIAMETER	18"	25"
DIMENSIONS		
WEIGHT (LBS)	202	325
LENGTH	65"	72"
WIDTH	33"	44"
HEIGHT	44"	43"
WARRANTY		
MACHINE	3 Year Limited Consumer, 90-Day Limited Commercial	3 Year Limited Consumer, 1 Year Limited Commercial
FEATURES		
ELECTRIC START	Standard	
HALOGEN HEADLIGHTS	N/A	Standard
ATTACHMENTS & ACCESSORIES		
OPTIONAL	Snow Cab, Turf Caster Kit, Melt-Buddy™	Debris Deflector, Snow Cab, Turf Wheels, MeltBud-dy™

PRODUCT NAME	27- Ton Log Splitter	34- Ton Log Splitter
MODEL NUMBER	917001	917002
ENGINE	Subaru®	Subaru®
DISPLACEMENT (cc)	169 cc	211 cc
STARTING SYSTEM	Recoil	Recoil
STARTING SYSTEM	.95 Gallon (3.6L)	.95 Gallon (3.6L)
LOG CAPACITY	25"	25"
HYDRAULIC CAPACITY	4.5 Gallon(17L)	4.5 Gallon(17L)
SPLITTING FORCE	27 Ton	34 Ton
CYLINDER PISTON SIZE	4.5" Bore	5" Bore
CYLINDER ROD SIZE	1.75"	1.75"
CYLINDER STROKE	24"	24"
PUMP SIZE	11 GPM	13 GPM
CYLINDER CYCLE TIME	16 Seconds	18 Seconds
TIRE SIZE	4.8" / 4" x 8"	4.8" / 4" x 8"
HITCH COUPLER	2"	2"
MAX TOWING SPEED	45 mph / 72.4 kmh	45 mph / 72.4 kmh
DIMENSIONS		
WEIGHT (LBS)	500	525
LENGTH (HORIZONTAL POSITION)	86.25"	86.25"
WIDTH	38.25"	38.25"
HEIGHT (HORIZONTAL POSITION)	46.50"	46.50"
WARRANTY		
MACHINE	3 Year Limited Consumer, 90-Day Limited Commercial	3 Year Limited Consumer, 90-Day Limited Commercial
FEATURES		
SPLITTING ORIENTATION	Vertical or Horizontal	
2-STAGE HYDRAULIC PUMP	Standard	
WHEEL FENDERS	Standard	
SAFETY CHAINS	Standard	
LEFT OR RIGHT HAND OPERATION	Standard	
ATTACHMENTS & ACCESSORIES		
OPTIONAL	Work Table, Trailer Lights, License Plate Holder, Engine Cover, Log Cradle, Lift Handle, Muffler Guard	

BE SURE TO ASK YOUR LOCAL DEALER ABOUT THESE OUTSTANDING ARIENS SNOW PRODUCTS.

THE KING OF SNOW

Durability. Reliability. Unrelenting power. That's what you'll find in the entire Ariens® Sno-Thro® lineup. Every machine is subjected to the most rigorous testing and trial conditions imaginable. So when winter brings on the worst, bring on the best—**The King of Snow**—built to last a lifetime. Consult with your Ariens dealer about selecting the Sno-Thro model that's right for you.



THE KING OF SNOW®



financing

The Right Card For The Perfect Lawn.

With more benefits and flexibility than ever before, the Yard Card and Yard Card PLUS financing programs allow you to shop with confidence.



- Special Financing offers* are available so you can select the plan that best fits your financing needs.
- Safe and secure online payment processing lets you make hassle free payments in a safe, secure environment.
- Consumer and Commercial programs available.
- Receive exclusive card-holder only savings and offers.
- Receive quick credit decisions with NO annual fee!

**Subject to credit approval. Subject to dealer participation. May not be available at all locations.*



Established in 1992, Sheffield Financial provides the simplest, quickest, and easiest means for consumer retail financing in the Outdoor Power Equipment Industry.

- 10 – 15 minute application process
- Competitive Financing Options
- All Loans are Installment Loans
 - Fixed Monthly Payments
 - Fixed Interest Rates
 - Fixed Loan Terms
- Check the status of your account and make payments online at www.sheffieldfinancial.com or call our automated Sheffield Express24 at 1-800-753-1903.
- Automatic monthly ACH debit to your checking account available at no charge
- Manage your cash flow with 6 Skip Pay coupons (certain conditions apply)
- No voice mail during normal business hours – talk to people, not a computer phone system

Apply Online Today!

www.sheffieldfinancial.com

Contact your local Ariens Dealer for details.

Phone: 1-800-438-8892 | Fax: 1-800-438-8894

All loans subject to credit approval
New Ariens equipment only
No required down payment (*excludes marginal credit*)
Not all dealers participate in finance programs

KOHLER® ENGINES

Designed to meet the high demands of even the biggest backyard enthusiasts, KOHLER® Courage® V-Twin and Pro™ V-Twin engines have the power to tackle any yard.

Keep your mower operating longer in harsh conditions.

Cool-running OHV design and tough cast-iron cylinder bore mean your engine will last longer in harsh mowing conditions – so you can keep your mower longer and avoid costly trips to the repair shop.

Have a lawn you're proud of.

Consistent-Cut™ technology delivers more consistent power to your mower deck in extreme load conditions, maximizing cutting, bagging and mulching performance. So you can rest assured knowing there will be less clumping and missed areas.

Smooth operation reduces user fatigue.

V-twin design runs more smoothly and reduces fatigue to operator's hands and feet – essential for the big jobs.

Find your next Kohler Engine one of the following mowers:

Zoom 42 – 20hp Courage V-Twin
Zoom 50 – 23hp Courage V-Twin
Zoom XL 42 – 22hp Courage V-Twin
Zoom XL 48 – 23hp Courage V-Twin

Zoom XL 54 – 24hp Courage V-Twin
Max Zoom 48 – 23hp Courage V-Twin
Max Zoom 52 – 23hp Courage V-Twin
Max Zoom 60 – 25hp Courage Pro

Spend less on fuel.

Overhead valve design makes KOHLER® engines more fuel efficient and provides more power per displacement while emitting fewer harmful exhaust gases.

Avoid costly service.

The KOHLER® Courage® Pro™ V-Twin engine's large-capacity filtration package offers extra protection between maintenance intervals.



visit us online

Get Product Information • Consumer Reviews * Locate Authorized Dealer • View Video of Ariens Products

www.ariens.com



Consumer Reviews



Video



Dealer Locator



Customer Support



Via Le Marze, 1 - 31010 ASOLO TV - Italia
tel. 0423 952314 - www.mvmenegon.it
info@mvmenegon.it - info@mvmenegon.com

Scan with mobile device

to get more information
on Ariens products.

www.ariens.com

